

FILO - 3

Technical Specifications

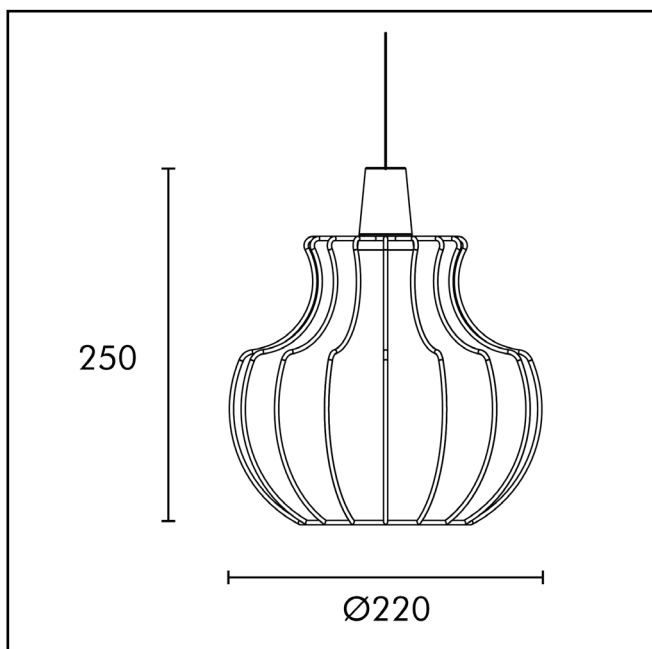

Product Code	DS17
Housing Material	Aluminium Rod & Wood
Environment	Indoor
Mounting	Pendant
Size	Ø220
Wattage	9W
Light Distribution	Direct
Body Finish	Powder Coated
Thermal Management	Passive Cooling
Input Voltage	230 - 240 AC 50Hz
Control	Switch
Connection	Plug-in Type Pre-wired
Appliance Class	Class 2
Ingress Protection	IP40
Photobiological Safety	RG 0 - No Risk
Ambient Temperature	0 to +50° C
Lamp	Filament Bulb
CCT	3000K / 6500K

- Specifications are subject to change without notice.
- Images can vary from the original product.
- Colors are based on RAL Standards.